

German engineering company, manufacturer and distributor of systems and components for the automation and process control industries



Engineering



Manufacturing



Distribution

Automation and Process Control from one hand with MEYLE engineering
Complete system solutions for the automation of machines and equipment in

- Factory automation
- Crane control
- Packaging machines
- Machine building
- Food production
- Beverage production
- Wind turbines and wind parks
- Steel and mining industry
- Oil- and refinery industry
- Chemical- and pharmaceutical industry
- Materials handling
- Robot and automated guided vehicle systems

Long term experience and competence in planning, engineering, commissioning and initial start up of industrial operations and processes with an engineering team of certified engineers (Dipl.-Ing.) from different fields who develop concepts and solutions using products from market leading manufacturers.

- Worldwide engineering service for system integration
- Manufacturing range of incremental, absolute and bus encoders, arc detection systems, safety switches, rotary gear limit switches, temperature-, flow-, level-, pressure sensors, limit switches and sensoric for automation and process control
- Distributor for market leading manufacturers
- Factory trained engineers
- Spare and maintenance parts management
- Consolidated shipments
- More than 10.000 customers worldwide
- More than 800 suppliers, next to standard distribution lines
- Large quantity purchase contracts with suppliers and call of orders
- 55 years market experience, ISO 9001:2015 certified since 1998



Meyer Industrie-Electronic GmbH – MEYLE

Carl-Bosch-Straße 8
 49525 Lengerich/Germany

Tel.: +49 (0)5481-9385-0
 Fax: +49 (0)5481-9385-12

Internet: www.meyle.de
 E-Mail: sales@meyle.de

1965-2020
55 Jahre

MEYLE®



MEYLE incremental and absolute encoders

Comprehensive range of incremental, absolute and bus encoders as solid shafts and hollow shaft versions. Heavy duty encoders, draw wire sensors, linear encoders and speed monitors.

MEYLE expanded the encoder program range that has been built up for over 20 years with new versions and over 40 years of know-how from IMG-Drehimpulsgeber which was integrated into Meyle group in 2021.

MEYLE heavy duty encoder

Encoder overspeed switch combinations, redundant encoders, encoders with large hollow shafts, robust encoders for conveyors and steel works.

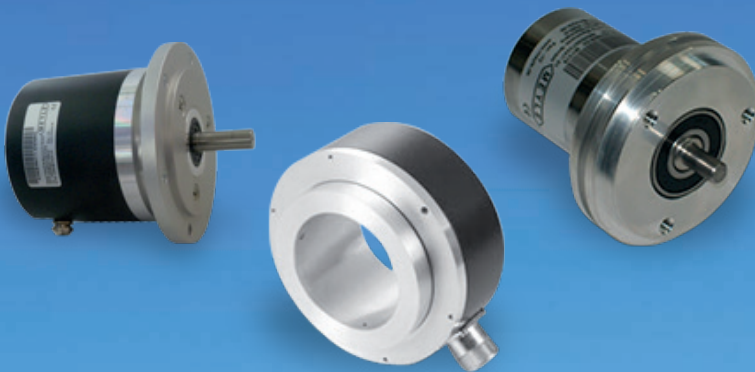

MEYLE arc detection systems

Arc detection systems for use in medium voltage switchgears for industrial plant and personal safety protection. Applications in energy distribution, power plants, mining, oil & gas, wind power and marine industries.



1965-2020
55 Jahre

MEYLE®

MEYLE solid flow transducers for mass flow measurement

The microwave transducer measures the flow of moving particles in pipes, operating maintenance free and without contact to the product. Simple installation in existing pipes and easy software calibration.

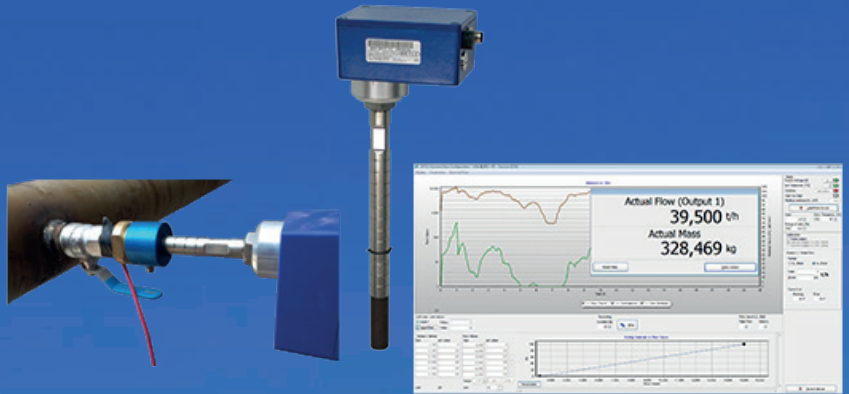

MEYLE pressure, level, flow and temperature measurement

Process measurements perfectly automated. Measurement technology for extreme conditions. Competent customer-specific support.

Pressure switch for industrial use and pressure transducers for demanding, long-term measurements.

Float switch with one or more switching points up to 3 m long

MEYLE has taken over the assets of Schmidt Mess- und Regeltechnik in 2024 and thus expanding its existing range of measurement and control technology with Schmidt Mess- und Regeltechnik products. Schmidt has been a competent partner to the industry since 1981 in the field of monitoring, controlling and display of:

- Flow
- Level
- Pressure
- Temperature
- Repair service for pressure transmitters and pressure gauges



MEYLE safety switches for conveyor belts and machine protection

Pull rope emergency switches, lever limit switches, safety switches, belt alignment switches, off-track belt switches, speed monitors, material flow switches and interlock bypass switches for use in harsh environments.

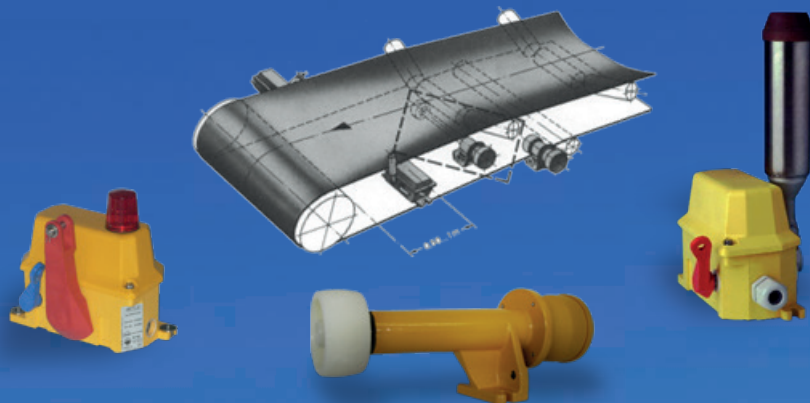

MEYLE ScrewGuard System for monitoring of detachable screw connections

Detecting relative rotational movements and loosening of screw nuts. Contactless on-site diagnosis with remote monitoring.

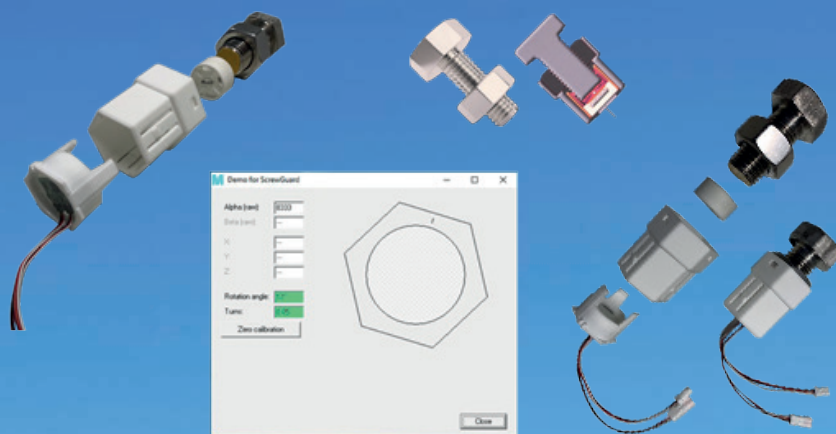

MEYLE systems and components for wind power applications

Encoders for pitch control, rotary gear limit switches for yaw control and pitch adjustment, wind sensors, personal safety equipment, industrial ethernet networking of wind farms, system integration and engineering for applications in wind power industry.



MEYLE sensors for automation technology

Magnetic sensors with high switching distances used i. e. in pigging technology, high temperature sensors, miniature optical, inductive and capacitive sensors, cylinder sensors, forked light barriers, as well as development of customized special sensor solutions.

Service of complete risk assessments in accordance with the applicable Machinery Directive and safety regulations.

MEYLE acquired the assets of Beta Sensorik in 2022 and hereby expands the existing MEYLE range of sensors with more than 25 years know-how of Beta Sensorik products and services.



MEYLE contactless signal and energy transmission in mechanical and plant engineering

Transmitting of up to 4 analog or 8 digital sensor signals, as well as power supply for sensors and actuators from a mobile unit contactlessly to a stationary unit.

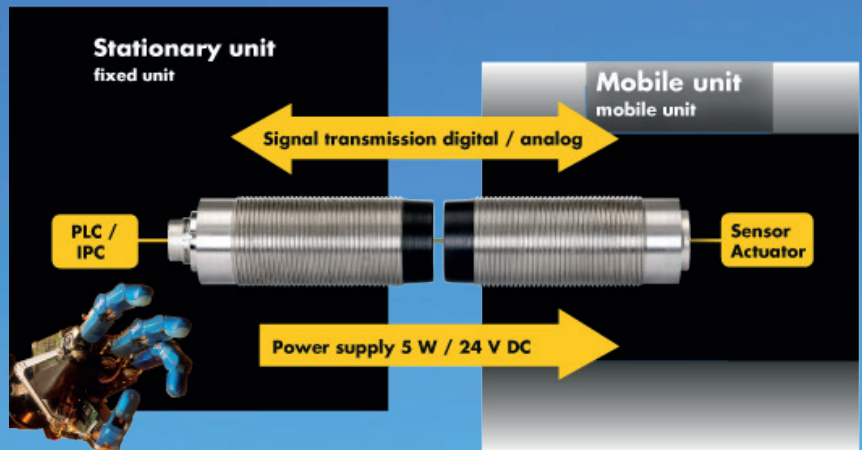

MEYLE engineering System integration and engineering company

Long expertise and experience in the areas of planning, engineering and commissioning of solutions for industrial procedures and processes.



MEYLE engineering System integrator and solution provider

Automation and process control from a single source as a solution provider for PLC technology, drive technology and process automation.

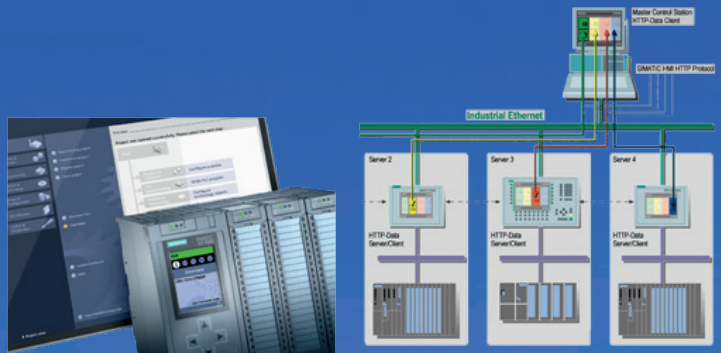

MEYLE process engineering Instrumentation and auto- mation solutions for process industries

Measuring instruments and automation solutions for process industries. Level, flow, temperature, pressure and analytical instruments as well as valves and actuators. System solutions for mining, food, oil & gas, water treatment and cement industries.



MEYLE outsourcing products

Acquisition of the tools, manufacturing equipment and customer relations for outsourcing and after market products. Production and quality assurance, as well as ensuring the delivery of compatible versions for ongoing demands, spare parts and for new applications worldwide.

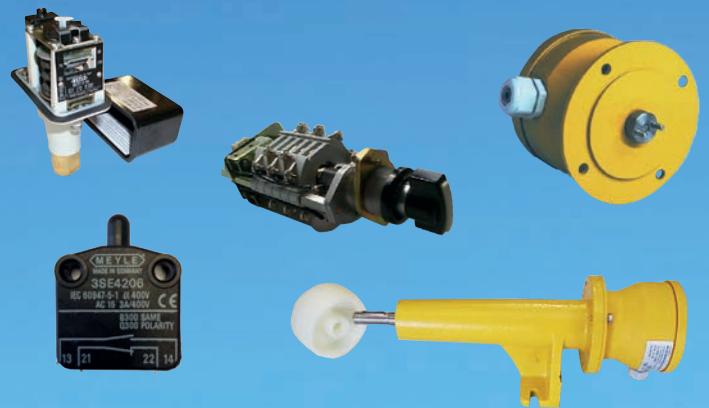

MEYLE distribution Systems and components for automation

Automation and process control from one hand. Complete system solutions for automation of machines and equipment using market leading manufacturers.

